

Technics

SE-A3

Stereo DC Power Amplifier

SU-A4

Stereo DC Control Amplifier



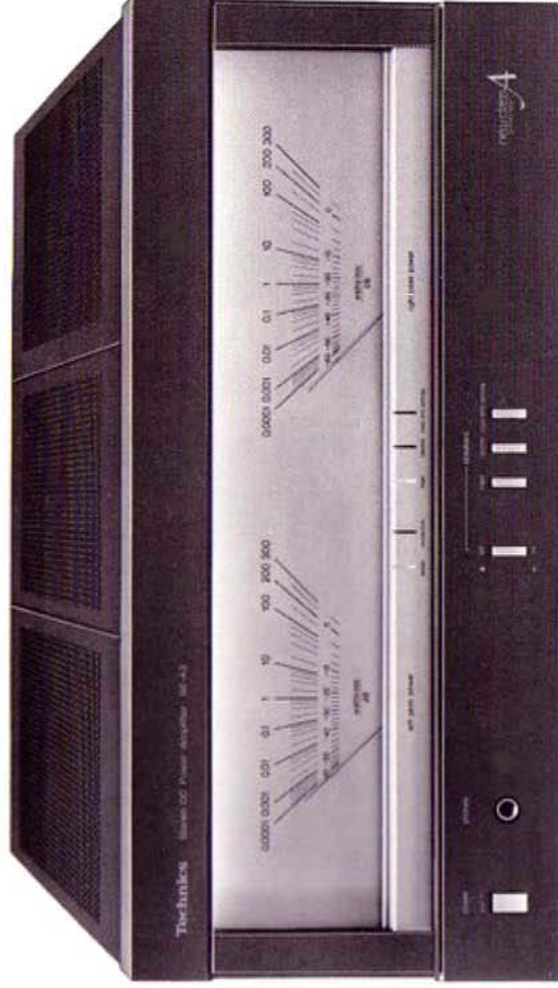

SE-A3 Stereo DC Power Amplifier

Our New Class A Circuitry Eliminates Switching and Crossover Distortion

The SE-A3 power amplifier employs our New Class A circuitry, and that makes it something special. New Class A is a unique Technics design that provides the distortion-free fidelity of class A amplifiers and the high power efficiency of class B (or AB) amplifiers. The SE-A3 delivers a rated output of 200 watts per channel, both channels driven into 8 ohms, with no more than 0.002% total harmonic distortion from 20 to 20,000 Hz. Signal-to-noise ratio is 123 dB (IHF '66), and TIM is so low that it is unmeasurable. Although these specifications speak for themselves, note that our New Class A circuitry eliminates the switching distortion and crossover distortion that are characteristic of conventional amplifiers other than the inefficient class A type. The SE-A3 power amp's freedom from such distortion is evident in an oscilloscope trace of its output waveform. And, the vibrant musicality you hear is the end result.



Class B amplifier output waveform and distortion waveform (at 20 kHz)

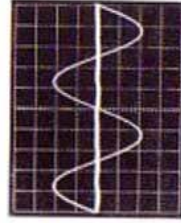

New Class A amplifier output waveform and distortion waveform (at 20 kHz)

Synchro Bias: The Key to Class A Fidelity with Class B Efficiency

Class A amplifiers use a single output transistor to handle the entire waveform. Class B and AB amplifiers use an "upper" transistor to handle the positive half-cycle, and a "lower" transistor to handle the negative half-cycle of the waveform.

The class A amplifier wastes a lot of power because the transistor is biased so that it draws a large idling current (the quiescent current drawn during zero input signal conditions). In contrast, the upper and lower transistors in a class B amplifier are biased so that there is no idling current drawn until the transistor is "turned on" so that it can begin amplifying either the positive or negative half-cycle. Therefore, class B is much more efficient. Unfortunately, the class B design also generates two kinds of distortion: "switching" and "crossover." Switching distortion, as its name implies, occurs when the

output transistors switch on and off as they begin and end their roles in the amplification process. This causes an asymmetrical waveform with pulsive distortion. Crossover distortion shows up as a nonlinear connection between the positive and negative half-cycles at the zero crossover point. At Technics we have eliminated both types of distortion by employing our original "synchro bias" circuit. This circuit is synchronized with the input waveform, and constantly supplies bias current to the power transistors so they do not turn off. There is no switching distortion. And crossover distortion is reduced to unmeasurable levels.

Although some manufacturers are offering superficially similar circuitry, a closer examination reveals that their variable bias circuitry depends on feedback of the output waveform. With this type of system, however, the bias current follows the same route as the audio signal circuitry, so that the bias current varies as needed. Because the bias current varies, it is difficult to achieve a completely symmetrical crossover, and crossover distortion becomes a problem.

In our New Class A design, the synchro bias circuit is separate from the audio signal route and employs high speed diodes for bias control. The response characteristics of these diodes permit a current waveform rising edge that is very close to the ideal parabolic function. So linearity is excellent at the zero cross point, and there is virtually no crossover distortion. Our 3DA (3-dimensional analysis) profile for the SE-A3 supports this ingenious design approach. Low distortion is maintained throughout a wide, smooth plane extending from 0.2 W to rated power (200 W) and from 10 Hz to 100 kHz.

Low Distortion DC Circuitry

While many of today's amplifier's tend to rely too much on negative feedback (NFB) to reduce distortion caused by basic amp circuitry, the SE-A3 design effectively reduces distortion before NFB is applied. Open-loop distortion is low, a condition that usually indicates outstanding sound quality.

The excellent open loop performance of the SE-A3 rests on elaborate DC circuitry employing no coupling capacitors from input jacks to output speaker terminals. (There are no capacitors in the feedback loop either.)

The first stage is a current mirror loaded bootstrap cascode differential circuit using one-chip dual FETs for thermal stability. These dual FET's reduce DC drift of the SE-A3 to a miniscule ± 10 mV between -10°C and $+50^{\circ}\text{C}$. Downstream circuitry includes a current mirror

loaded double cascode differential voltage amp stage, a 2-stage class A SEPP driver stage, the synchro bias circuit, a 2-parallel SLPT (Super Linear Power Transistor) push-pull driver, and a 4-parallel DLPT (Dual Linear Power Transistor) output stage. Also, by utilizing NFB properly we have achieved incredibly low distortion of no more than 0.002% at rated output of 200 W + 200 W, both channels driven into 8 ohms from 20 Hz to 20,000 Hz. At half rated power, distortion drops to 0.001% or less, so low that it is no longer detectable by most test instruments. Frequency response is DC~300 kHz (-3 dB), signal-to-noise ratio is 123 dB (IHF '66), and slew rate is 200 V/ μs .

Concentrated Power Block Cuts Electromagnetic Induction

Current flow creates magnetic fields which, in turn, can affect other signals in nearby circuits. Such "electromagnetic induction" is a problem when dealing with the power supply and output transistors.

That is why we utilize something called the "concentrated power block," or CPB, for short. In our CPB, all circuitry handling large currents is

connected by the shortest routes possible to help protect small signal circuitry from adverse interference.

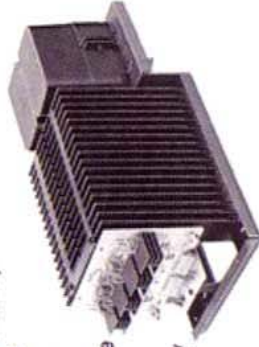

Super Audio Capacitors, DLPTs, and 3-Layer Bus Lines for High Frequency Handling Ability

The DLPTs in the output stage were developed specifically for the SE-A3. These consist of matched NPN and PNP power transistors manufactured together in a symmetrical configuration so that emitter resistance is not dispersed. The result is an output waveform that looks very much like a class A waveform.

We also utilize low-impedance electrolytic capacitors for audio applications. Four low-inductance flat capacitors connected in parallel make up one of these plastic encased super audio capacitors. Two such 22,000 μF capacitors are used for each audio channel. 3-Layer laminated bus lines are used for the positive and negative power supply and output power line.

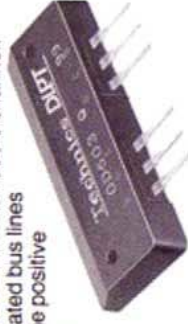

Independent Left and Right Channel Power Transformers

To eliminate chances of cross-channel interference, we have equipped this amp with separate transformers for the left and right stereo channels. The voltage amplification stage employs a stabilized voltage power supply with a stabilized current buffer.

Large Peak Power Meters

These large, high quality meters have an attack time of only 50 μs and give direct readings from 0.0001W to full power.

Other Features

- Pushbutton speaker system selection: A, B, A+B, off.
- Protection relay with automatic recovery and LED indicator.
- DC low-cut (2 Hz) input jacks in addition to regular jacks.

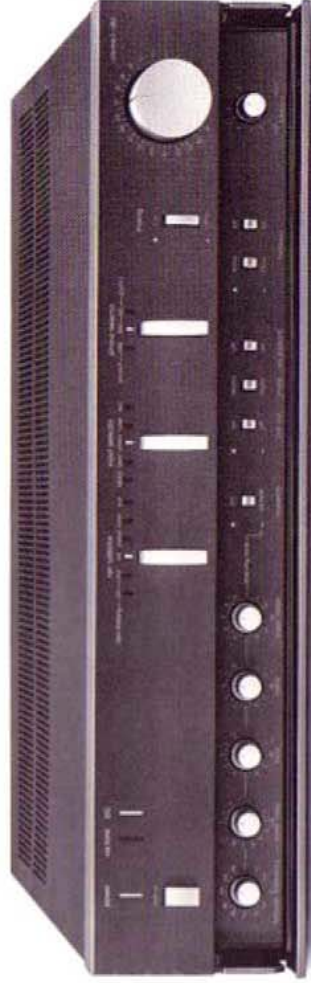

SU-A4 Stereo DC Control Amplifier

State-of-the-Art Performance for Today's Audio Systems

The SU-A4 is a state-of-the-art control amp. It follows in the tradition of the SU-A2 introduced two years ago, just as the SE-A3 power amp follows the well respected SE-A1.

Besides this unit's impeccable credentials as a phono EQ preamp, it handles control functions in an audio system. To prevent switching and crossover distortion, all amplifier stages are class A. ICL circuitry includes the MM and MC inputs employing FETs. And the only coupling capacitors are one for downstream MC and another for MM, making this amp capable of straight DC amplification from AUX inputs to output.

Thanks to a special buffer amp, output impedance is so low that you can put your power amp as close to a speaker system as possible, yet have the SU-A4 convenient to your listening position without affecting waveform fidelity. Bass and Super-Treble controls, Super-Bass and Super-Treble controls let you effectively deal with typical audio equalization problems.

Class A Circuitry Throughout

Thanks to class A amplifier circuitry from input to output, the reproduced waveform is completely free from switching and crossover distortion. Open loop performance is so good that little NFB is required.

Straight DC Circuitry

All high-level inputs (tuner, tape, aux) encounter no capacitors in the signal path. FETs are employed to eliminate the need for input capacitors. When used with a DC power amp such as the SE-A3, this means that DC amplification extends all the way to the speaker terminals, the advantage of which can be seen in the excellent 3DA profile obtained for this control amplifier. Basic circuitry consists of the ICL preamp (MC), ICL phono equalizer amp, DC flat amp and a buffer amp. Distortion is extremely low and frequency response extends from DC to 250 kHz (-3 dB), thanks to the 2-stage flat amp

and buffer amp construction with a current mirror loaded cascode differential input stage employing matched dual FETs and an SEPP output stage employing SLPTs (Super Linear Power Transistors) which feature an extremely high f_T .

Ultra-Low Noise FET Inputs for Phono EQ and MC Pre-preamp

The design utilizes ICL (Input Capacitor-Less) circuitry employing ultra-low noise FETs, and only one coupling capacitor for the phono EQ and another for the MC pre-preamp. This contributes to excellent phono specifications such as: 90 dB S/N for MM cartridges (2.5 mV, IHF '66), 78 dB for MC (250 μ V, IHF '66), 0.001% distortion (20 Hz ~ 20 kHz, MM \rightarrow preout), and RIAA deviation of ± 0.15 dB (20 Hz ~ 20 kHz). Phono overload is prevented by the MM maximum input of 260 mV/47 kilohms and MC of 10 mV/47 ohms.

No matter what type of preamp circuitry you compare these specs with, it is obvious that the SU-A4 offers true state-of-the-art performance. An equalizer subsonic filter is provided to prevent amplification of subsonic noise that might be transmitted from record warps or off-center spindle holes.

Extremely Low Output Impedance Allows Remote Power Amp Placement

Placing the power amp close to the speaker system can improve damping ability, so speaker cone movement is better controlled. However, this can cause unexpected problems such as self-oscillation when the preamp is placed far away from the power amp if the output impedance of preamp is too high. Unfortunately, this is the case with many preamps. But not with the SU-A4. Because the A4's buffer amp drops output impedance to a mere 0.2 ohm, so low that you could use up to 110 yards of shielded wire for connections, or connect as many as 2,500 power amps without problems. This is why a 20 kHz square wave can be reproduced with such excellent fidelity.

A current limiter protection circuit is provided to protect the output stage from accidental short circuiting.

Super-Bass and Super-Treble Controls for Equalization

To obtain outstanding low and high frequency response with today's audio systems and source material, you need more equalization facilities than are supplied on conventional preamps. That is why we have developed new Super-Bass and Super-Treble controls in addition to the regular bass and treble controls on the SU-A4.

The Super-Bass control has a steep 12 dB/octave slope to give a shelving boost of as much as 12 dB and thereby extend speaker system bass response by as much as one full octave. The turnover frequency is continuously adjustable from 50 Hz to 200 Hz to give you precise control with any speaker system.

Naturally, this Super-Bass is also very helpful for dealing with other low frequency problems such as those caused by listening room acoustics or speaker position. Boorness of this variety can be dealt with by attenuating the conventional bass tone control and then turning up the Super-Bass. In the high range, the typical response problems are caused by phono cartridge characteristics. MM cartridges often exhibit dips around 5-6 kHz and MC cartridges may have annoying high range peaks. By using the regular treble control and the Super-Treble control where appropriate, you can obtain flat response for almost all situations.

Of course, all tone control circuitry can be switched out by turning off the VIA TONE switch. This gives you pure straight DC amplification (indicated by a front panel LED).

Shelving Tone Control Characteristics

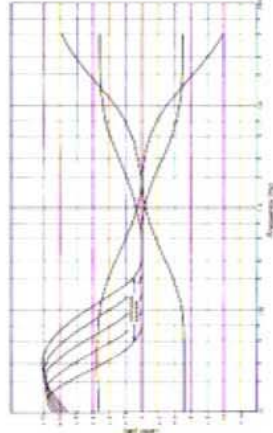

Carefully Selected Electronic Components

Conductive plastic (CP) and multi-contact brushes are used for the volume control and all selectors and switches. The volume control is 2-ganged for each channel (on either side of the flat amp) to prevent noise when the volume is turned down. Extremely accurate decibel indications, aligned with the aid of a computer, contribute to handling convenience. Metal film type resistors are used throughout to obtain a 15 dB improvement in distortion at 30 kHz as compared with ordinary carbon resistors. The extra-large transformer contributes to this amp's outstanding signal-to-noise ratio.

Other Features

- A loudness tap is provided on the CP volume control. This is switchable between two turnover frequencies: 500 Hz for small speakers, and 250 Hz for large speaker systems.
- 20 dB audio muting switch.
- REC OUT mode selector for greater tape deck handling flexibility.
- Two sets of preout jacks and two preout on/off switches.
- Removable control panel door and control setting memo card.
- All rear panel jacks are gold plated.
- Two sets of phono input terminals and two sets of tape terminals.

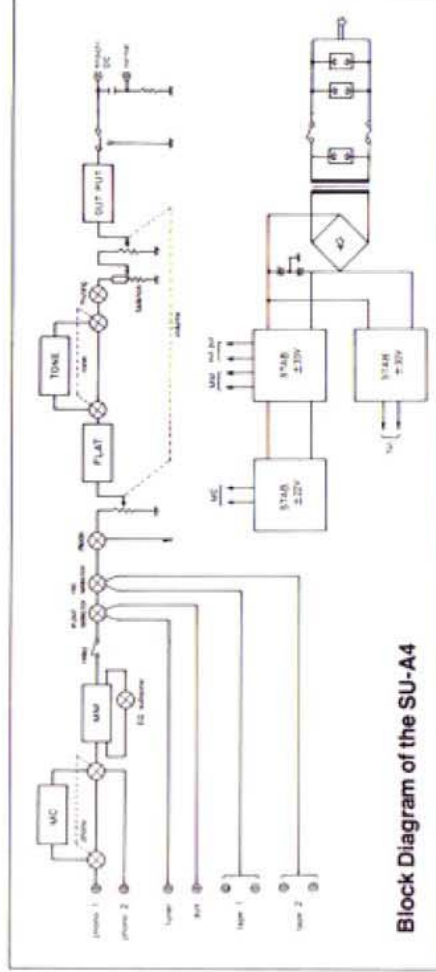

Block Diagram of the SU-A4

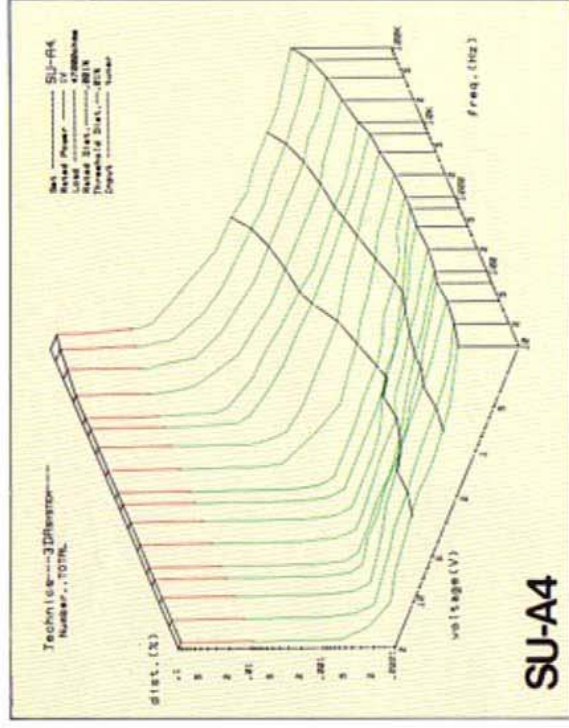
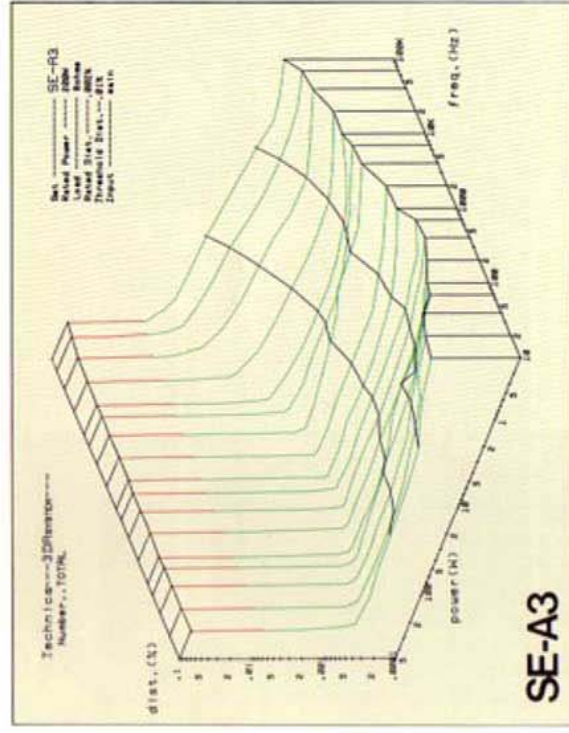

Technical Specifications (IHF '78)

SE-A3

AMPLIFIER SECTION

Rated minimum sine wave RMS power output
20 Hz~20 kHz both channels driven
0.002% total harmonic distortion
200 W per channel (8 ohms)
20 Hz~20 kHz both channels driven
0.003% total harmonic distortion
320 W per channel (4 ohms)
1 kHz continuous power output both channels driven
0.001% total harmonic distortion
220 W per channel (8 ohms)
0.003% total harmonic distortion
350 W per channel (4 ohms)
Dynamic headroom
1.1 dB (8 ohms),
1.8 dB (4 ohms)
Total harmonic distortion
rated power
0.002% (20 Hz~20 kHz, 8 ohms)

half power

0.001% (20 Hz~20 kHz, 8 ohms)
0.0003% (1 kHz, 8 ohms)
SMPTA intermodulation distortion
0.002% (8 ohms)
Transient intermodulation distortion
unmeasurably small
Low frequency damping factor
200 (8 ohms), 100 (4 ohms)
Load impedance
MAIN or REMOTE
MAIN+REMOTE
Frequency response
DC~20 kHz, +0, -0.1 dB
DC~300 kHz, +0, -3 dB
70 mV (1 V IHF '66)
Input sensitivity
Signal-to-noise ratio (IHF, A)
100 dB (123 dB, IHF '66)
47 kilohms
Input impedance
47 kilohms

SU-A4

Frequency response
PHONO MC/MM
20 Hz~70 kHz RIAA ± 0.15 dB
TUNER, AUX, TAPE
DC~250 kHz +0, -3 dB
+0, -0.1 dB (DC~20 kHz)
Maximum output voltage
PHONO MM
15 V (30 Hz~15 kHz)
PHONO MC
15 V (30 Hz~15 kHz)
TUNER, AUX, TAPE
15 V (20 Hz~20 kHz)
Rated output voltage
Output
2 V
Rec out
150 mV
Total harmonic distortion
PHONO MM
0.001% (20 Hz~20 kHz)
PHONO MC
0.0015% (20 Hz~20 kHz)
TUNER, AUX, TAPE
0.001% (20 Hz~20 kHz)
Input sensitivity
PHONO MM
0.63 mV (2.5 mV, IHF '66)
PHONO MC
25 μ V (100 μ V, IHF '66)
TUNER, AUX, TAPE
36 mV (150 mV, IHF '66)

Signal-to-noise ratio (IHF A)
PHONO MM
80 dB (90 dB, IHF '66)
PHONO MC
80 dB (78 dB, 250 μ V input, IHF '66)
TUNER, AUX, TAPE
100 dB (105 dB, IHF '66)
Maximum input voltage
PHONO MM
260 mV (300 mV, 1 kHz)
PHONO MC
10 mV (12 mV, 1 kHz)
Input impedance
PHONO MM
47 kilohms
PHONO MC
47 ohms
TUNER, AUX, TAPE
47 kilohms
Shelving tone
SUPER TREBLE (50 kHz)
-10 dB~+10 dB
TREBLE (20 kHz)
-5 dB~+5 dB
BASS (50 Hz)
-5 dB~+5 dB
SUPER BASS (20 Hz, 12 dB/oct.)
0 dB~+12 dB
Turnover frequency
SUPER TREBLE
8 kHz
TREBLE
2 kHz

METER

Reading range
0.0001 W~300 W (8 ohms)
-60 dB~+5 dB
Frequency response (reading accuracy)
(logarithmic compression)
10 Hz~20 kHz ± 1 dB
(more than -40 dB)
10 Hz~10 kHz ± 1 dB
(less than -40 dB)
Attack time
750 msec (0 dB \rightarrow -20 dB)
Recovery time
50 μ sec
GENERAL
Power consumption
1,400 VA, 1,150 W
Power supply
AC 120 V, 60 Hz
Dimensions
16-15/16" \times 8-3/16" \times 19-31/32"
(W \times H \times D)
(430 \times 208 \times 507 mm)
Weight
78.3 lb (35.2 kg)

Note: Total harmonic distortion is measured by the digital spectrum analyzer (HP 3045 system).

SUPER BASS (12 dB/oct.)

50 Hz~200 Hz continuously adjustable
500 Hz
BASS
Filter
EQ subsonic filter
20 Hz, -12 dB/oct.
Loudness control (VR at -30 dB)
TURNOVER FREQUENCY 250 Hz
TURNOVER FREQUENCY 500 Hz
+8 dB at 25 Hz
+8 dB at 50 Hz
Output impedance
OUTPUT
220 ohms
REC OUT
-20 dB
Muting
GENERAL
Power supply
AC 120 V, 60 Hz
Power consumption
60 W
Dimensions
16-15/16" \times 8-3/16" \times 14-3/16"
(W \times H \times D)
(430 \times 97 \times 360 mm)
Weight
19.4 lb (8.8 kg)

Note: Total harmonic distortion is measured by the digital spectrum analyzer (HP 3045 system).

Technics

Panasonic Company
Division of Matsushita Electric Corporation of America
Professional Audio Division